

Rama

1 50kg

udźwig na
1 skrzydło load per
1 leaf



łożyska
kulkowe ball
bearings

dostępne kolory profili - available colors of profiles

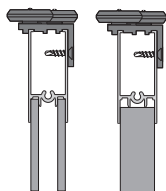

opcje z ramiakami - options with connectors

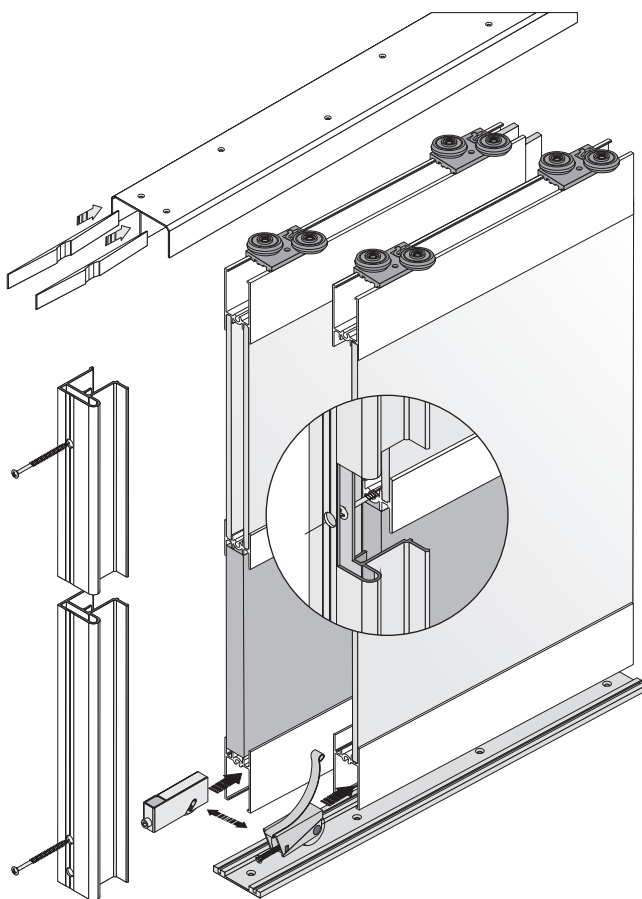
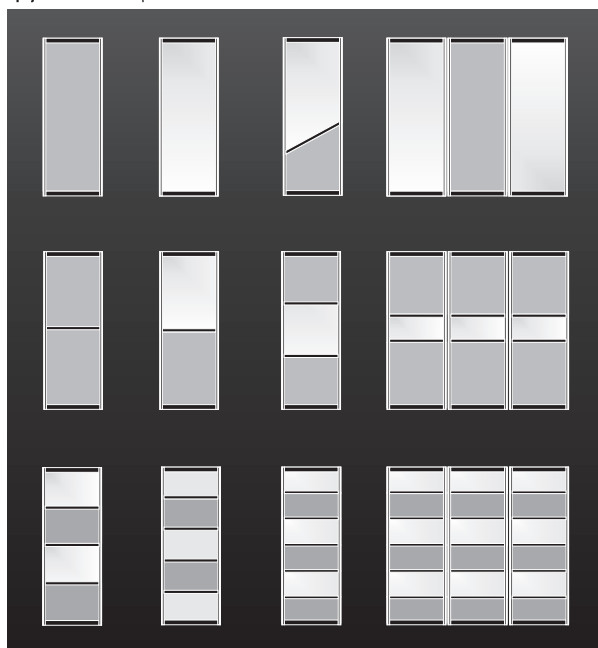

zestaw Rama 50kg - Rama 50kg kit

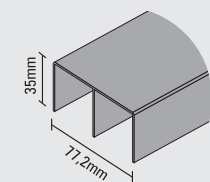

nr 8840

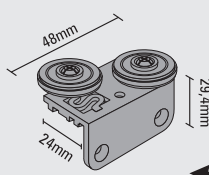

nr 8823

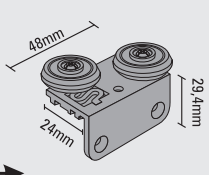

nr 8822

← zamiennie interchangeable →

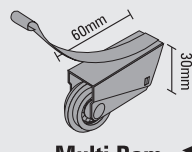

Multi Ram
nr 8817

← zamiennie interchangeable →

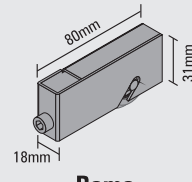

Rama
nr 8810

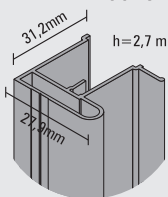

Rama R-4/16/18
nr 8820

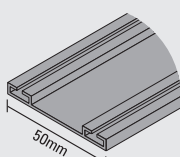

nr 8850

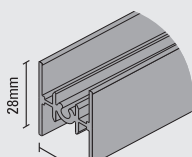

nr 8870

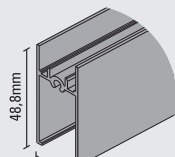

nr 8830

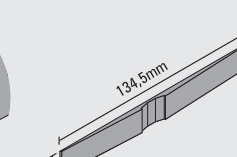

nr 8802

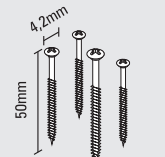

zestaw wkrętów
bots kit

produkty dobierane indywidualnie - individually selected accesories

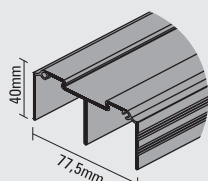

nr 8210

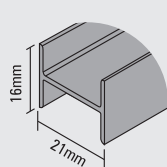

nr 8180

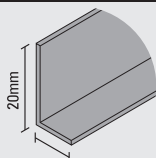

L-10÷20
nr 8640

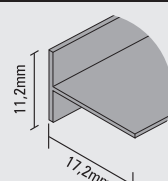

nr 8510

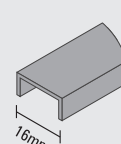

C-16
nr 8650

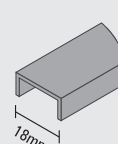

C-18
nr 8660



SR
nr 0089



SR
nr 0088

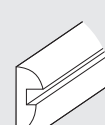

U-16
nr 8815



wzór zastrzeżony -
design proprietary



Rama R-4/16/18
nr 8820

komplet Rama 50kg - Rama 50kg set

ilość skrzydeł number of leaves	 8080
	2
 ZAMIENNIE/INTERCHANGEABLE	2
 ZAMIENNIE/INTERCHANGEABLE	2
	1

elementy podstawowe - basic elements

ZAMIENNIE/
INTERCHANGEABLE



Multi Ram
nr 8817



Rama
nr 8810

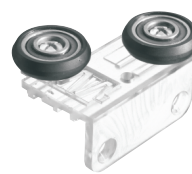

nr 8822

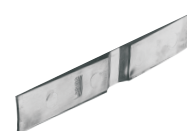

nr 8802



nr 8840



nr 8850

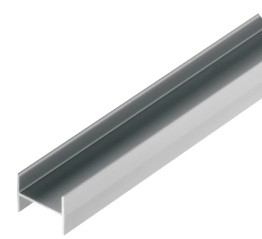

nr 8180



nr 8830



nr 8870

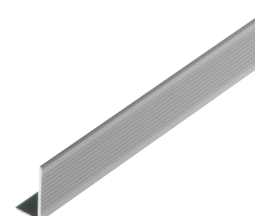

L-10÷20
nr 8640

dostępne kolory - available colors



naturalny
natural
nr 000(0)



szampański
champagne
nr 000(4)



jasny złoty
light gold
nr 000(5)



czarny
black
nr 000(6)