

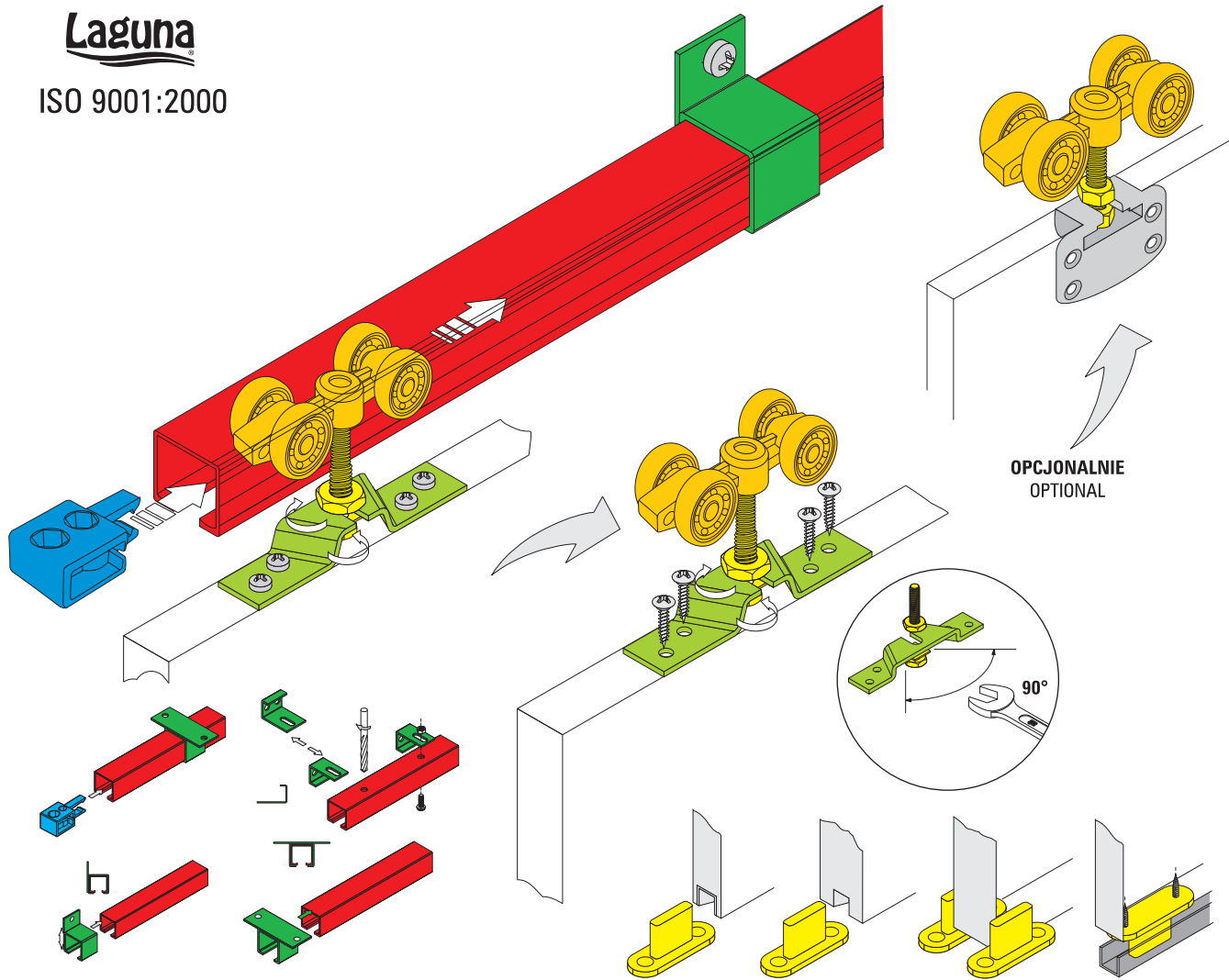

**Laguna**

ISO 9001:2000



## komplet Standard 100kg - Standard 100kg set

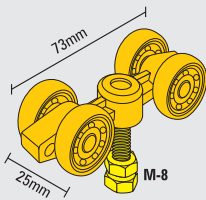

**MP-100**  
nr 1120

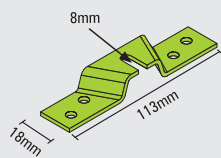

**PB-075**  
nr 1121

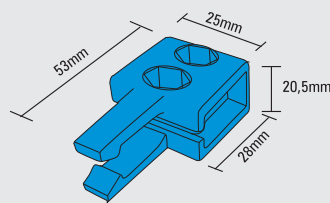

**KPZ-075**  
nr 1141

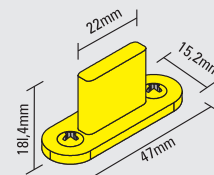

**AO-075**  
nr 1150

## produkty dobierane indywidualnie - individually selected accesories

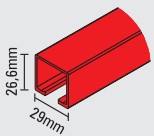

**K-075**  
nr 1

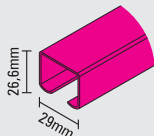

**K-076**  
nr 13

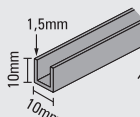

**C-10**  
nr 6

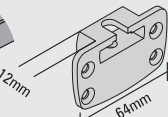

**PBB-075**  
nr 1180

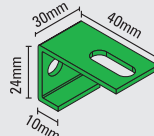

**SK-075**  
nr 1130

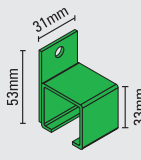

**SKU-075**  
nr 1131

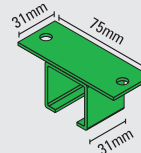

**KK-075**  
nr 1132

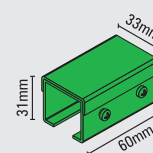

**LKU-075**  
nr 1133

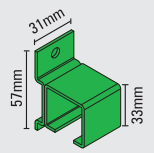

**SKL-075**  
nr 1134

dostępne w opcjach - available in options



art.poj/single goods









komplet/set



zestaw/kit

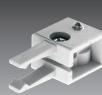

komplet Standard 100kg - Standard 100kg set

ilość skrzydeł number of leaves	 1162	 1163
	2	4
	2	4
	2	2
	2	4

wzór zastrzeżony - design proprietary

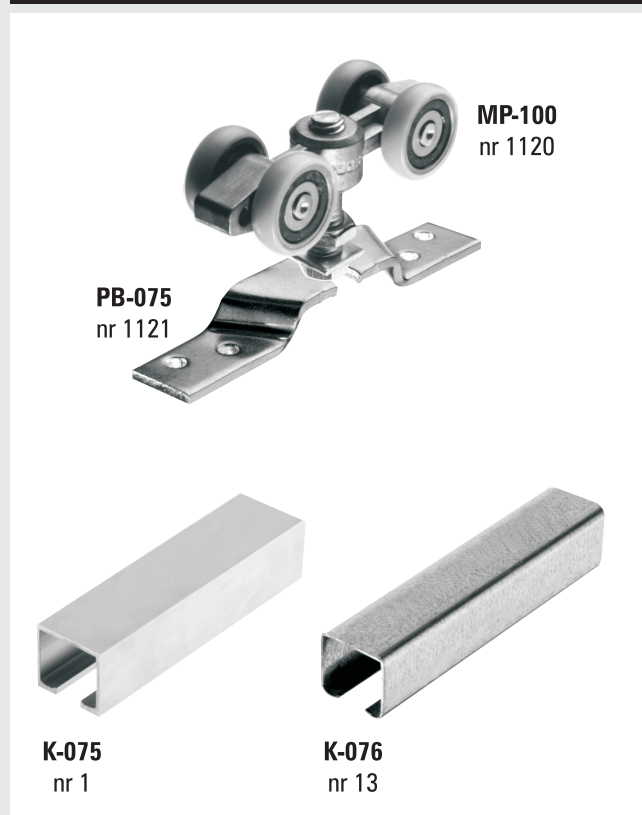

uchwyty do ścian - wall fasteners

uchwyty do sufitu - ceiling fasteners



SK-075  
nr 1130



SKU-075  
nr 1131



SKL-075  
nr 1134



KK-075  
nr 1132

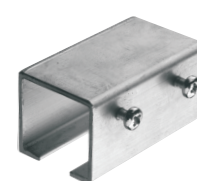

LKU-075  
nr 1133