

opcja z płyta - option with board

system aluminiowy aluminium system

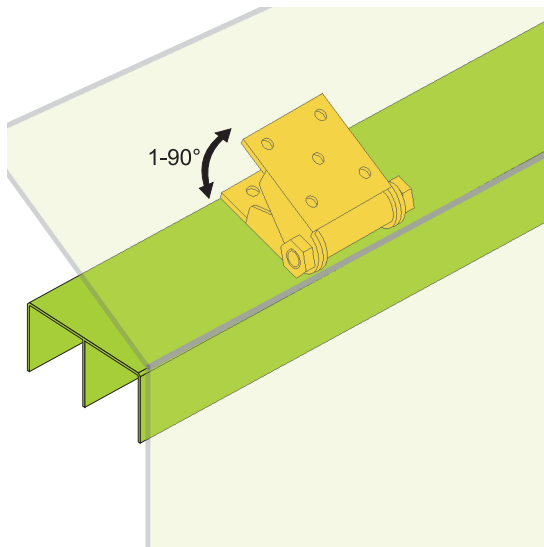

uchwyt do mocowania toru górnego pod skosem
fastening to upper rail installed to sloping ceilings

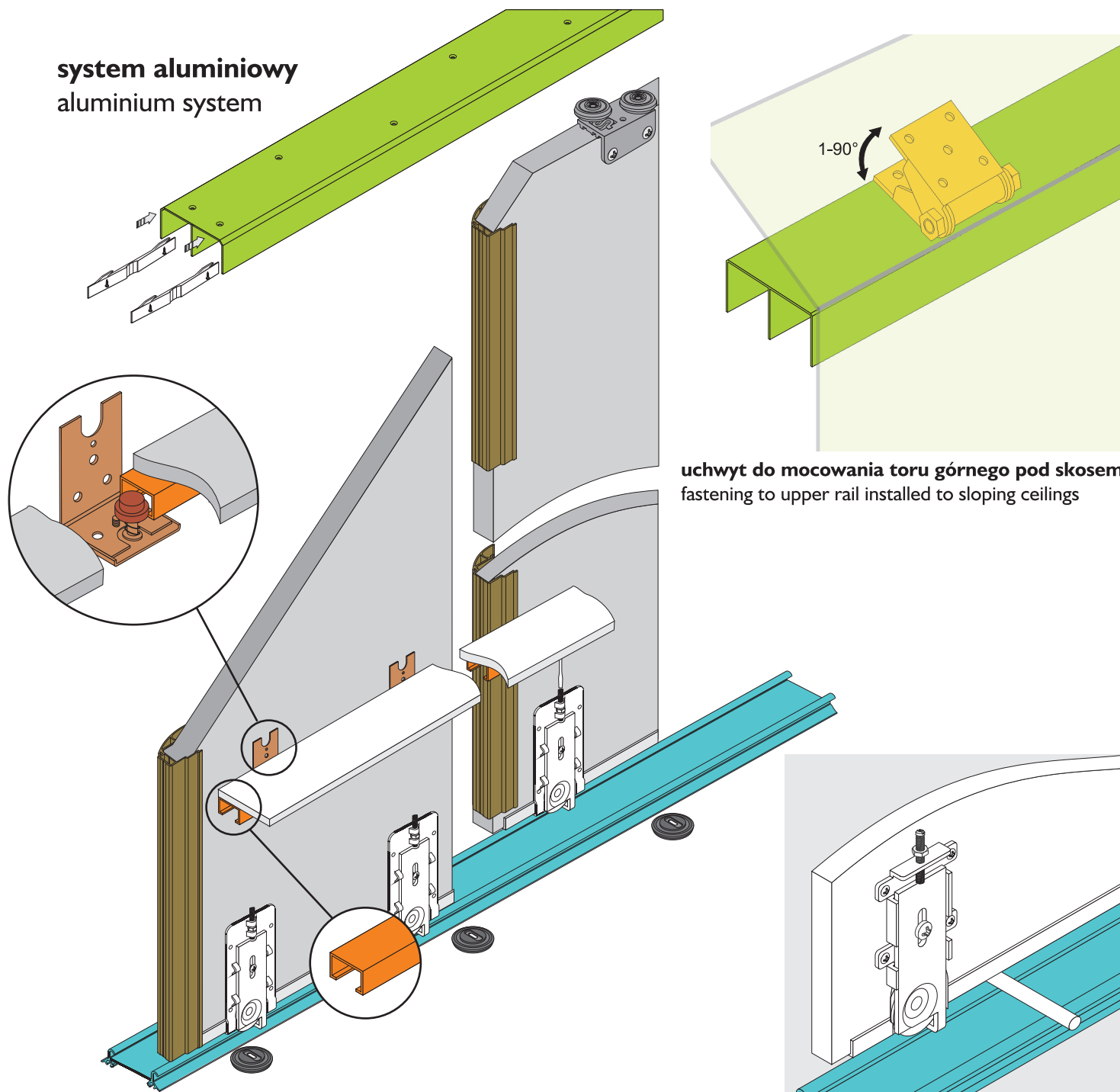
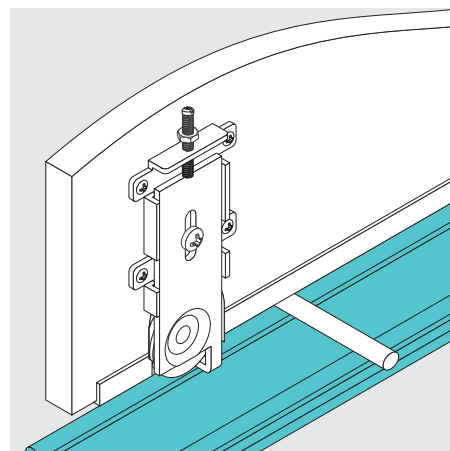

elementy podstawowe - basic elements

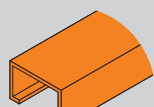

szyna K-015 nr 3
rail K-015 nr 3

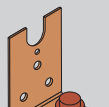

przewodnik
do zabudów po skosie
guide for sloping furnishings
nr 8192

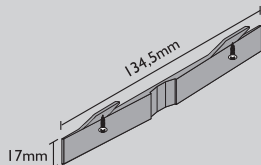

nr 8802



nr 8203

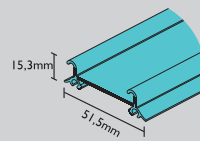

nr 82090

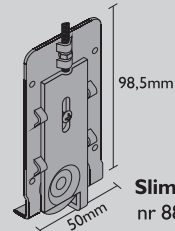

Slim SL
nr 8800

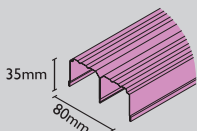

stal lakierowana
lacquered steel
nr 1817.5

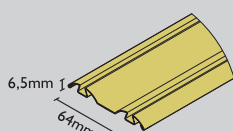

stal lakierowana
lacquered steel
nr 1815.5

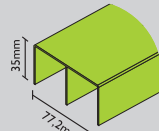

nr 8840



nr 8823

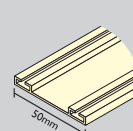

nr 8850

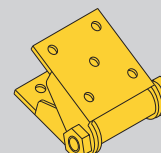

nr 8082

opcja z lustrem/szkłem - option with mirror/glass

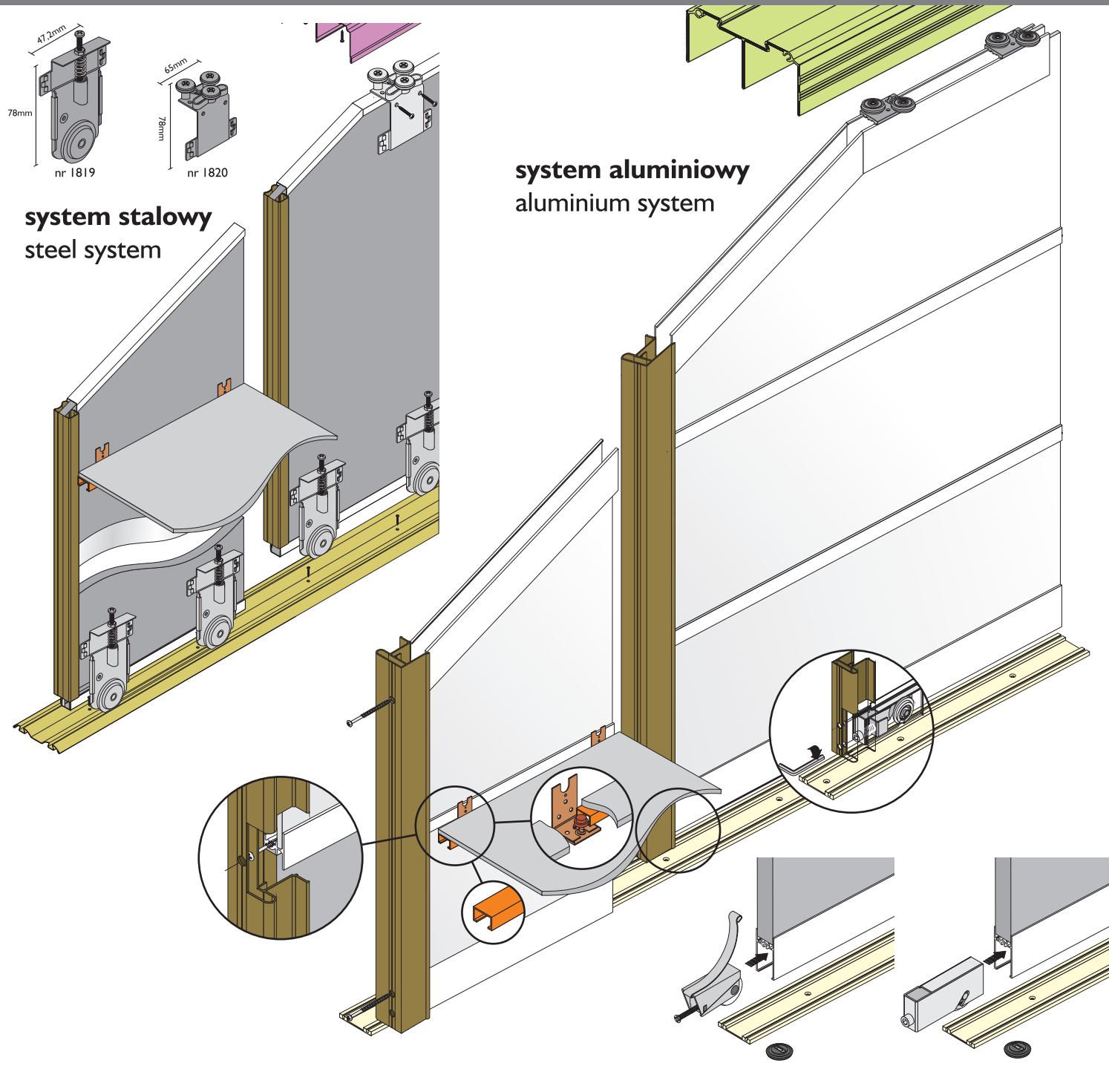

system stalowy
steel system

system aluminiowy
aluminium system

elementy dobierane indywidualnie - individually selected elements

