

# Rama Plus

**1** 50kg

udźwig na  
1 skrzydło load per  
1 leaf



łożyska  
kulkowe ball  
bearings

dostępne kolory profili - available colors of profiles



naturalny  
natural  
nr 000(0)

szampański  
champagne  
nr 000(4)

jasny złoty  
light gold  
nr 000(5)

czarny  
black  
nr 000(6)

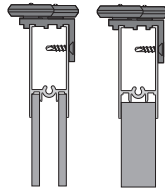

opcje z ramiakami - options with connectors

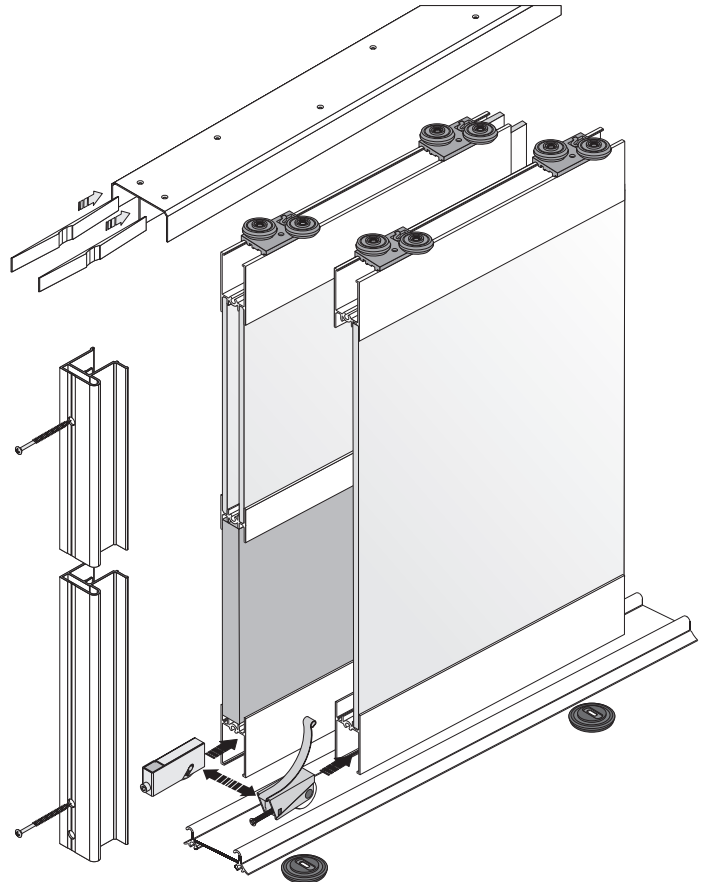
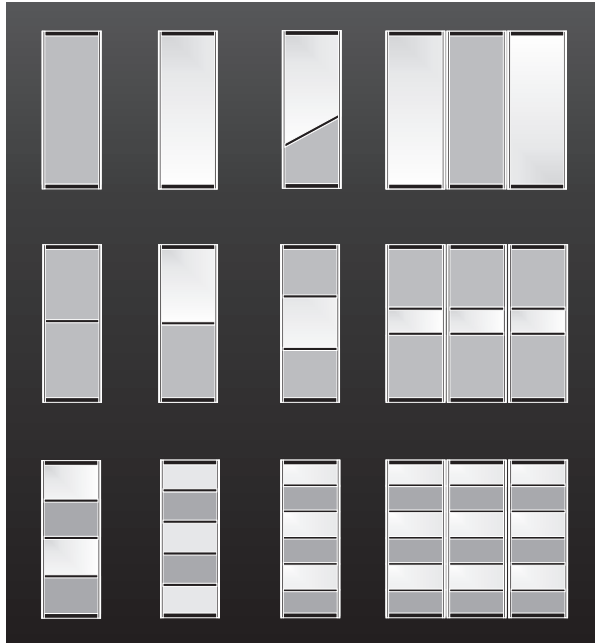

## zestaw Rama Plus 50kg - Rama Plus 50kg kit

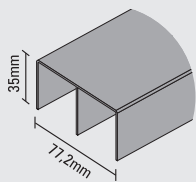

nr 8840

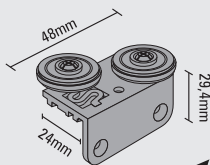

nr 8823

zamiennie  
interchangeable

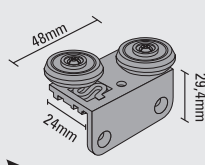

nr 8822

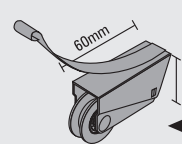

Multi Om  
nr 8816

zamiennie  
interchangeable

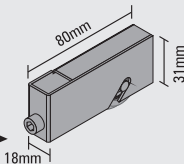

Rama Plus  
nr 8814

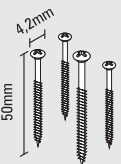

zestaw wkrętów  
nr 8815  
bolts kit

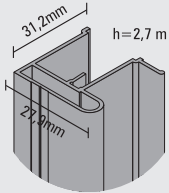

Rama R-4/16/18  
nr 8820

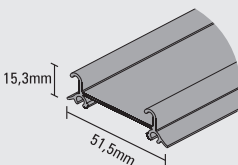

nr 8209

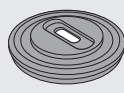

nr 8203

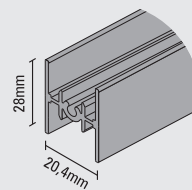

nr 8870

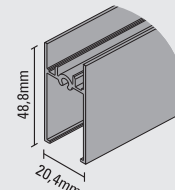

nr 8830

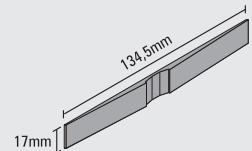

nr 8802

## produkty dobierane indywidualnie - individually selected accesories

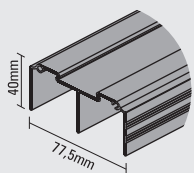

nr 8210

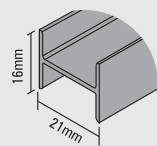

nr 8180

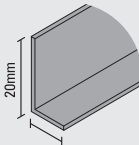

L-10÷20  
nr 8640

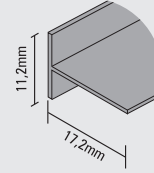

nr 8510

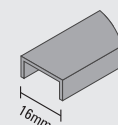

C-16  
nr 8650

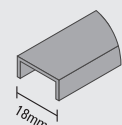

C-18  
nr 8660



nr 8206



SR  
nr 0089



SR  
nr 0088



U-16  
nr 8815



wzór zastrzeżony -  
design proprietary



**Rama R-4/16/18**  
nr 8820

komplet Rama Plus 50kg - Rama Plus 50kg set

ilość skrzydeł number of leaves	8081
	2
 ZAMIENNIE/INTERCHANGEABLE	2
 ZAMIENNIE/INTERCHANGEABLE	2
	1

elementy podstawowe - basic elements

ZAMIENNIE/  
INTERCHANGEABLE



**Multi Om**  
nr 8816



**Rama Plus**  
nr 8814

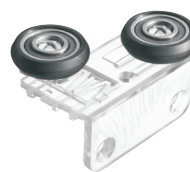

nr 8822



nr 8203



nr 8840



nr 8209



nr 8180



nr 8830



nr 8870

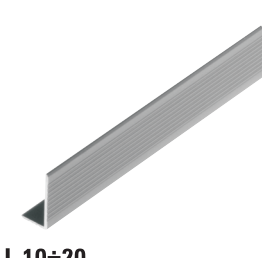

**L-10÷20**  
nr 8640

dostępne kolory - available colors



**naturalny**  
natural  
nr 000(0)



**szampański**  
champagne  
nr 000(4)



**jasny złoty**  
light gold  
nr 000(5)



**czarny**  
black  
nr 000(6)